

Mixed Trimethylphosphine–Trimethylphosphite Pentacoordinate d⁸ Nickel(II) Complexes

PIERRE F. MEIER, ANDRÉ E. MERBACH

Institut de Chimie Minérale et Analytique, Université de Lausanne, 3, Place du Château, CH-1005 Lausanne, Switzerland

MICHÈLE DARTIGUENAVE and YVES DARTIGUENAVE

Laboratoire de Chimie de Coordination du CNRS, Associé à l'Université P. Sabatier, 205 Route de Narbonne, F-31030 Toulouse, France

Received May 15, 1979

The products of the reactions of PMe_3 or $\text{P}(\text{OMe})_3$ with trigonal bipyramidal $\text{NiX}_2(\text{PMe}_3)_3$ ($X = \text{CN}, \text{Cl}, \text{Br}, \text{I}$), $[\text{NiX}(\text{PMe}_3)_4]\text{BF}_4$ and $[\text{Ni}(\text{P}(\text{OMe})_3)_5](\text{BF}_4)_2$ complexes have been studied in dichloromethane and chlorodifluoromethane solutions. The stereochemistries of the mixed ligand complexes have been investigated by ^{31}P NMR spectroscopy at low temperature. Relations between the NMR parameters (δ ; $^2J_{\text{PP}}$), the structures and stereochemistries are discussed [1].

Introduction

Although ligand substitution and addition reactions have been widely studied for heavy metal–phosphine complexes [2–3], few reports are available on first-row d⁸ metal complexes with monodentate tertiary phosphine ligands. Furthermore, most of these studies have been essentially focused on the stereochemistry of the compounds and on their dynamic solution behaviour, *i.e.* inter- and intramolecular ligand exchange processes. The importance of five coordinate d⁸ species as intermediates in ligand substitution processes ($\text{S}_{\text{N}}1$ and $\text{S}_{\text{N}}2$) [2] and the few studies reported in the literature, led us to investigate the Ni(II)– PMe_3 system [4–5]. The characterization of the species present in solution and the determination of the rates and mechanisms of inter- and intramolecular PMe_3 exchange in the trigonal bipyramidal (TBP) five coordinate $\text{NiX}_2(\text{PMe}_3)_3$, $[\text{NiX}(\text{PMe}_3)_4]^+$ ($X = \text{CN}, \text{Cl}, \text{Br}, \text{I}$) and $[\text{Ni}(\text{PMe}_3)_5]^{++}$ species was achieved by ^{31}P NMR and electronic spectroscopies. As a continuation of this work, it seemed interesting to study ligand substitutions in these complexes by ligands as different as carbon monoxide [6] and trimethylphosphite. These substitutions are important since they are related to the selectivity of processes involving these species in molecular catalysis. We report here the results of the

reaction of $\text{P}(\text{OMe})_3$ with $\text{NiX}_2(\text{PMe}_3)_3$, $\text{NiXY}(\text{PMe}_3)_3$ and $[\text{NiX}(\text{PMe}_3)_4]^+$ ($X, Y = \text{CN}, \text{Cl}, \text{Br}, \text{I}$). The reaction of PMe_3 with $[\text{NiP}(\text{OMe})_3)_5]^{2+}$ has also been studied. Due to the stereochemical non-rigidity of these pentacoordinate Ni(II) complexes at ambient temperature, their study was undertaken at low temperature (220–115 K) where ^{31}P NMR slow exchange limit spectra were obtained.

Experimental

Chemicals

Dichloromethane (Fluka, anal. grade) was distilled twice from P_2O_5 and stored over molecular sieves (4 Å). Dichloromethane-2D (CEA, France) and chlorodifluoromethane (Freon 22, DuPont) were used without further purification. Trimethylphosphite (Fluka) was distilled from sodium under a nitrogen atmosphere. Trimethylphosphine [7] and the following complexes were synthesized according to known methods: $\text{Ni}(\text{CN})_2(\text{PMe}_3)_3$ [8], $\text{NiX}_2(\text{PMe}_3)_3$ ($X = \text{Cl}, \text{Br}, \text{I}$) [9], $[\text{NiX}(\text{PMe}_3)_4]\text{BF}_4$ ($X = \text{Cl}, \text{Br}, \text{I}$) [5], $[\text{Ni}(\text{P}(\text{OMe})_3)_5](\text{BF}_4)_2$ [10], $[\text{NiX}(\text{PMe}_3)_4]\text{X}$ ($X = \text{Cl}, \text{Br}, \text{I}$) [5], $[\text{NiX}(\text{PMe}_3)_3]\text{BF}_4$ is obtained when deoxygenated argon is bubbled through a dichloromethane solution of the carbonyl $[\text{NiX}(\text{CO})(\text{PMe}_3)_3]\text{BF}_4$ complex ($X = \text{Cl}, \text{Br}$) [5].

NMR Sample Preparation

The solid complexes were weighed in a nitrogen atmosphere glove box (KSE) directly into 10 mm NMR tubes. The solvents were deoxygenated in an all-glass/teflon vacuum-line by the freeze–pump–thaw technique and vacuum distilled onto the solid samples. Solutions of mixed $\text{NiXY}(\text{PMe}_3)_3$ ($X, Y = \text{CN}, \text{Cl}, \text{Br}, \text{I}$) complexes were prepared *in situ* by weighing stoichiometric amounts of $\text{NiX}_2(\text{PMe}_3)_3$ and $\text{NiY}_2(\text{PMe}_3)_3$ into the sample tubes. Solutions of the complexes $\text{NiX}_2(\text{PMe}_3)_2(\text{P}(\text{OMe})_3)$, NiXY –

TABLE I. $^{31}\text{P}\{^1\text{H}\}$ NMR Data for Some Trigonal Bipyramidal Complexes of Ni(II) Containing PMe_3 .

Complex	δ_{P_a} ^a	δ_{P_e} ^a	$J_{\text{P}_a\text{P}_e}$ ^b	Solvent	T (K)	χ^c
$\text{Ni}(\text{CN})_2(\text{PMe}_3)_3$	—	−18.4 (s)	—	CH_2Cl_2	183	12.78
$\text{NiCl}_2(\text{PMe}_3)_3$	−0.4 (d)	−35.0 (t)	78.7	CH_2Cl_2	173	11.84
$\text{NiBr}_2(\text{PMe}_3)_3$	−3.7 (d)	−30.4 (t)	71.6	CH_2Cl_2	183	11.68
$\text{NiI}_2(\text{PMe}_3)_3$	−8.6 (d)	−28.0 (t)	59.8	CH_2Cl_2	193	10.60
$\text{NiClBr}(\text{PMe}_3)_3$	−2.8 (d)	−31.5 (t)	75.0	CH_2Cl_2	178	11.75
$\text{NiClI}(\text{PMe}_3)_3$	−7.0 (d)	−32.5 (t)	69.6	CH_2Cl_2	178	11.22
$\text{NiBrI}(\text{PMe}_3)_3$	−6.2 (d)	−28.8 (t)	65.7	CH_2Cl_2	178	11.13
$\text{NiBr}(\text{CN})(\text{PMe}_3)_3$	−2.1 (d)	−26.7 (t)	85.7	CH_2Cl_2	178	11.22
$[\text{NiCl}(\text{PMe}_3)_4]\text{Cl}$	+1.5 (t)	−28.7 (t)	79.4	CHClF_2	114	11.07
$[\text{NiCl}(\text{PMe}_3)_4]\text{BF}_4$	+1.0 (t)	−28.8 (t)	82.5	CHClF_2	114	11.07
$[\text{NiBr}(\text{PMe}_3)_4]\text{Br}$	−15.7 (s) ^d	—	—	CHClF_2	114	11.98
$[\text{NiBr}(\text{PMe}_3)_4]\text{BF}_4$	−2.6 (t)	−29.2 (t)	79.4	CH_2Cl_2	178	10.98
$[\text{NiI}(\text{PMe}_3)_4]\text{I}$	−18.4 (s) ^d	—	—	CHClF_2	114	10.45
$[\text{NiI}(\text{PMe}_3)_4]\text{BF}_4$	−5.2 (t)	−29.2 (t)	76.5	CH_2Cl_2	178	10.45
$[\text{Ni}(\text{PMe}_3)_5](\text{BF}_4)_2$	+0.9 (q)	−32.7 (t)	70.6	CHClF_2	114	10.30

^aIn ppm. ^bIn Hz, absolute values. ^cSum of the electronegativities of the donor atom of the ligands: $\chi = \sum \chi_i$ with $\chi_{\text{Cl}} = 2.83$, $\chi_{\text{Br}} = 2.74$, $\chi_{\text{I}} = 2.21$, $\chi_{\text{P}} = 2.06$, $\chi_{\text{CN}} = 3.3$. ^dThe presence of a singlet instead of two triplets is due to very fast intramolecular PMe_3 exchange.

$(\text{PMe}_3)_2(\text{P}(\text{OMe})_3)$, $[\text{NiX}(\text{PMe}_3)_2(\text{P}(\text{OMe})_3)_2]\text{X}$ and $[\text{NiBr}(\text{PMe}_3)_2(\text{P}(\text{OMe})_3)_2]\text{BF}_4$ ($\text{X}, \text{Y} = \text{CN}, \text{Cl}, \text{Br}, \text{I}$) were prepared *in situ* by weighing stoichiometric amounts of $\text{NiX}_2(\text{PMe}_3)_3$, $\text{NiY}_2(\text{PMe}_3)_3$, $[\text{NiBr}(\text{PMe}_3)_4]\text{BF}_4$ and $\text{P}(\text{OMe})_3$ into the sample tubes. The species $[\text{Ni}(\text{PMe}_3)_5](\text{BF}_4)_2$ was prepared *in situ* by vacuum distilling an excess of PMe_3 onto $[\text{Ni}(\text{PMe}_3)_4](\text{BF}_4)_2$. Solutions of the complexes $[\text{Ni}(\text{PMe}_3)_X(\text{P}(\text{OMe})_3)_Y](\text{BF}_4)_2$ ($\text{X} = 2, 3, 4; \text{Y} = 3, 2, 1$) were prepared by adding known amounts of PMe_3 to solutions of $[\text{Ni}(\text{P}(\text{OMe})_3)_5](\text{BF}_4)_2$ in the vacuum line. All tubes were sealed under vacuum and stored in liquid nitrogen before recording the spectra.

NMR Measurements

Variable temperature $^{31}\text{P}\{^1\text{H}\}$ FT NMR spectra were recorded at 36.43 MHz using a Bruker HX-90 spectrometer equipped with a B-SV 3 PM pulser, a B-SV 3 B proton noise decoupler, a B-ST 100/700 temperature regulating unit and a Nicolet BNC-12 data system. The low temperature spectra (113 to 153 K) were obtained at 24.28 MHz using a Bruker WP-60 spectrometer with multinuclei facilities. Field-frequency stabilisation was achieved on an internal ^2D signal at 21.14 kG and on an external ^{19}F signal at 14.09 kG. The temperature of the samples was measured before and after each spectrum by a method described elsewhere [11].

Chemical Shift Referencing

PEt_3 in a capillary is used as ^{31}P chemical shift reference. The chemical shift of PEt_3 being tempera-

ture dependent (about 0.027 ppm/K), the chemical shift difference between PEt_3 and 62.5% H_3PO_4 (eutectic) was measured as a function of temperature. All chemical shifts are reported with respect to 62.5% H_3PO_4 . Positive chemical shifts are downfield from the H_3PO_4 standard.

NMR Parameter Determination

In the case of first-order $^{31}\text{P}\{^1\text{H}\}$ NMR spectra, the chemical shifts of the various ligands and the phosphorus–phosphorus coupling constants were determined directly from the digitalized spectra. For the non first-order $^{31}\text{P}\{^1\text{H}\}$ NMR spectra, the coupling constants and chemical shifts have been determined by best fit of the spectra using the iterative LAOCOON 4 program. As all the non first-order spectra are very close to first order, we used first-order nomenclature in the tables, *i.e.* doublet, triplet and quartet, for clarity.

Determination of the equilibrium constants was made by integration of the ^{31}P NMR signals of each complex.

Results and Discussion

The ^{31}P NMR data for the different complexes are reported in Tables I and II. The slow exchange limit spectra were obtained in dichloromethane or chlorodifluoromethane solutions at low temperature (114–193 K).

TABLE II. $^{31}\text{P}\{^1\text{H}\}$ NMR Data for Some Trigonal Bipyramidal Complexes Containing PMe_3 and $\text{P}(\text{OMe})_3$ as Ligands in CH_2Cl_2 at 173 K.

Complex	$\delta_{\text{P}_a}^a$	δ_{P_e}	$\delta_{\text{P}'_a}$	$\delta_{\text{P}'_e}$	$J_{\text{P}_a\text{P}_e}^b$	$J_{\text{P}_a\text{P}'_e}$	$J_{\text{P}_e\text{P}'_a}$	$J_{\text{P}_e\text{P}'_e}$	$J_{\text{P}_a\text{P}'_a}$	$J_{\text{P}_e\text{P}'_a}$	$J_{\text{P}_a\text{P}'_e}$	χ
$\text{Ni}(\text{CN})_2(\text{PMe}_3)_2(\text{P}(\text{OMe})_3)$	+19.4(d)			+128.6(t)		66.6						12.78
$\text{NiBr}_2(\text{PMe}_3)_2(\text{P}(\text{OMe})_3)$	+7.0(d)			+111.0(t)		88.0						11.66
$\text{NiI}_2(\text{PMe}_3)_2(\text{P}(\text{OMe})_3)$	0.0(d)			+113.7(t)		75.3						10.60
$\text{NiBr}(\text{PMe}_3)_2(\text{P}(\text{OMe})_3)$	+3.9(d)			+114.0(t)		80.1						11.13
$[\text{NiCl}(\text{PMe}_3)_2(\text{P}(\text{OMe})_3)_2]\text{Cl}$	+19.6(t)			+108.0(t)		99.9						11.07
$[\text{NiBr}(\text{PMe}_3)_2(\text{P}(\text{OMe})_3)_2]\text{Br}$	+15.9(t)			+106.2(t)		97.6						10.98
$[\text{NiI}(\text{PMe}_3)_2(\text{P}(\text{OMe})_3)_2]\text{I}$	+10.6(t)			+102.4(t)		92.4						10.45
$[\text{NiBr}(\text{PMe}_3)_2(\text{P}(\text{OMe})_3)_2]\text{BF}_4$	+15.6(t)			+106.0(d.t)		97.6						
$[\text{NiBr}(\text{PMe}_3)_3(\text{P}(\text{OMe})_3)]\text{BF}_4$	+8.3(d.d)	-32.6(d.t)		+116.6(d.t)	69.7	96.9		361				
$[\text{Ni}(\text{PMe}_3)_4(\text{P}(\text{OMe})_3)](\text{BF}_4)_2$	+83.6(d.q)	-15.7(d.d)	+134.5(d.q)		85.0	93.6		636				
$[\text{Ni}(\text{PMe}_3)_3(\text{P}(\text{OMe})_3)_2](\text{BF}_4)_2$		-14.6(t)	+120(q)			97.7						
$[\text{Ni}(\text{PMe}_3)_2(\text{P}(\text{OMe})_3)_3](\text{BF}_4)_2$	+22.8(q)			+108.9(t)		91.0						
$[\text{Ni}(\text{P}(\text{OMe})_3)_5](\text{BF}_4)_2^c$			+114.4	+110.8							120	

^aIn ppm, P_a is for axial PMe_3 , P_e is for equatorial PMe_3 , P'_a is for axial $\text{P}(\text{OMe})_3$, P'_e is for equatorial $\text{P}(\text{OMe})_3$.^bIn Hz, absolute values.^cIn CHClF_2 at 140 K, ref. 12.TABLE III. Equilibrium Constants K for the Reaction: $\text{NiX}_2(\text{PMe}_3)_3 + \text{NiY}_2(\text{PMe}_3)_3 \rightleftharpoons 2\text{NiXY}(\text{PMe}_3)_3$ in CH_2Cl_2 at 173 K.

X	Y	K
Cl	Br	25
Cl	I	1
Cl	CN	$<10^{-3}$
Br	I	6.5
Br	CN	0.15

Mixed Halide and Pseudo-halide Complexes: $\text{NiXY}(\text{PMe}_3)_3$ ($X, Y = \text{CN}, \text{Cl}, \text{Br}, \text{I}$)

In order to get a better knowledge of the solution chemistry and before studying the phosphine-phosphite substitution in the molecular $\text{NiX}_2(\text{PMe}_3)_3$ complexes, it was of interest to follow the halide substitution. The resulting complexes were obtained in solution by mixing equimolar amounts of $\text{NiX}_2(\text{PMe}_3)_3$ and $\text{NiY}_2(\text{PMe}_3)_3$. The equilibrium constants of reaction (1)

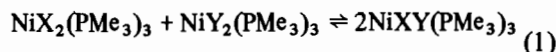

were obtained by integration of the uncoupled ^{31}P NMR spectra and are listed in Table III. The solution structure of the $\text{NiX}_2(\text{PMe}_3)_3$ complexes were determined previously [4]. Analysis of the ^{31}P NMR data of pure and mixed complexes (Table I) indicates that their structures are similar. We thus propose the following stereochemistry for $\text{NiClBr}(\text{PMe}_3)_3$ (I_a , $X = \text{Cl}, Y = \text{Br}$), $\text{NiI}(\text{PMe}_3)_3$ (I_b , $X = \text{Cl}, Y = \text{I}$) and $\text{NiBrI}(\text{PMe}_3)_3$ (I_c , $X = \text{Br}, Y = \text{I}$).

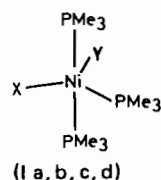

Fig. 1 is an example of the ^{31}P NMR spectra obtained by mixing $\text{NiCl}_2(\text{PMe}_3)_3$ and $\text{NiBr}_2(\text{PMe}_3)_3$. We can see from this spectrum that the signals associated with $\text{NiCl}_2(\text{PMe}_3)_3$ are somewhat broadened. This is due to the intramolecular PMe_3 exchange and shows that this exchange is faster than the intermolecular halide exchange. As seen in Table III, the complex $\text{Ni}(\text{CN})\text{Cl}(\text{PMe}_3)_3$ is not formed at concentrations detectable by NMR. The species $\text{Ni}(\text{CN})\text{Br}(\text{PMe}_3)_3$ presents a ^{31}P NMR pattern of the A_2B type, similar to that of the halo-complexes *i.e.* a low field doublet and a high field triplet suggesting the two possible stereochemistries I_d ($X = \text{Br}, Y = \text{CN}$) and II . In all the trigonal bipyramidal complexes of $\text{Ni}(\text{II})$ we investigated, the ^{31}P resonance associated to the axial trimethylphosphine is downfield of the resonance of the equatorial one (Table I). Thus the stereoisomer I_d is the most

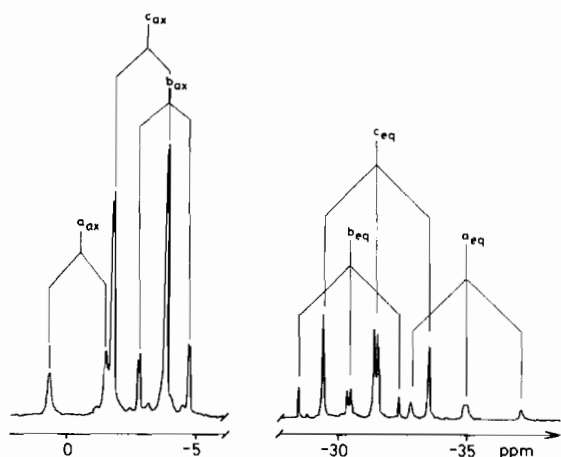
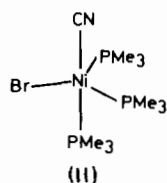

Fig. 1. $^{31}\text{P}\{^1\text{H}\}$ FT NMR spectra at 36.43 MHz of an equimolar mixture of $\text{NiCl}_2(\text{PMe}_3)_3$ (a) and $\text{NiBr}_2(\text{PMe}_3)_3$ (b) in CH_2Cl_2 at 178 K showing the presence of the mixed $\text{NiClBr}(\text{PMe}_3)_3$ (c) complex. The low field peaks are due to the axial (ax) phosphines and the high field ones to the equatorial (eq) phosphines. Numerical data in Table I. The spectra are of the A_2B type.



probable. The same behaviour has been observed by Meakin and Jesson [12] in various Ni(II) complexes of phosphines and phosphites. When mixing $\text{NiI}_2(\text{PMe}_3)_3$ and $\text{Ni}(\text{CN})_2(\text{PMe}_3)_3$ in the sample tube, a dark solid precipitates immediately. This reaction has not been studied.

Mixed PMe_3 - $\text{P}(\text{OMe})_3$ Complexes

Reactions of $\text{P}(\text{OMe})_3$ with $\text{Ni}(\text{CN})_2(\text{PMe}_3)_3$ (*trans*-TBP), $\text{NiX}_2(\text{PMe}_3)_3$ (*cis* eq-eq-TBP), $[\text{NiX}(\text{PMe}_3)_4]^+$ (C_{2v} -TBP) were carried out. Due to the impossibility of getting $[\text{Ni}(\text{PMe}_3)_5]^{2+}$ (TBP) as a starting material and with the aim of studying ligand exchange on a cationic $[\text{NiL}_5]^{2+}$ compound, we studied the reaction of PMe_3 with $[\text{Ni}(\text{P}(\text{OMe})_3)_5]^{2+}$ (BF_4) $_2$. Phosphorus NMR is especially suited to identifying the stereochemistries of the products since there is an unequivocal separation of the PMe_3 and $\text{P}(\text{OMe})_3$ chemical shifts. We note that $\text{P}(\text{OMe})_3$ moves upfield on coordination while PMe_3 moves downfield, both relative to the free ligands.

$\text{Ni}(\text{CN})_2(\text{PMe}_3)_3$

Addition of a large excess of $\text{P}(\text{OMe})_3$ to a dichloromethane solution of $\text{Ni}(\text{CN})_2(\text{PMe}_3)_3$ (ratio 10:1) leads to the formation in solution at 173 K of a new dicyano-complex containing two PMe_3 and one $\text{P}(\text{OMe})_3$ molecules as ligands. The ^{31}P NMR

spectrum of this complex, $\text{Ni}(\text{CN})_2(\text{PMe}_3)_2(\text{P}(\text{OMe})_3)$, shows two equivalent phosphines ($\delta = +19.4$ ppm) coupled to one phosphite ($\delta = +128.6$ ppm; $^2J_{\text{PP}'} = 66.6$ Hz). This is consistent with the three TBP isomers III, IV and V.

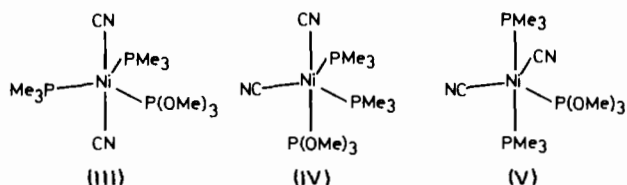

The cyanide groups have been reported to occupy the axial positions of the TBP in complexes containing phosphine ligands [13]. The coupling constant $^2J_{\text{P}(\text{OMe})_3\text{PMe}_3}$ (Table II) between equatorial PMe_3 and equatorial $\text{P}(\text{OMe})_3$, in an analogous complex is high (361 Hz) and in this cyano complex $^2J_{\text{PP}'}$ is only 66.6 Hz. Moreover, the chemical shift of the phosphine is +19.4 ppm, that is, in a region where the signal associated with an equatorial phosphine has never been observed. Thus, stereoisomer V is the most probable for this complex. However, a distortion of the TBP towards a square pyramid along the nickel-phosphite bond (in isomers III and V) cannot be excluded.

$\text{NiX}_2(\text{PMe}_3)_3$ ($X = \text{Cl}, \text{Br}, \text{I}$)

Addition of excess $\text{P}(\text{OMe})_3$ to dichloromethane solutions of $\text{NiX}_2(\text{PMe}_3)_3$ ($X = \text{Cl}, \text{Br}, \text{I}$) leads to the formation of the new molecular $\text{NiX}_2(\text{PMe}_3)_2(\text{P}(\text{OMe})_3)$ and cationic $[\text{NiX}(\text{PMe}_3)_2(\text{P}(\text{OMe})_3)_2]^+$ X species, according to reactions (2) and (3). The low temperature ^{31}P NMR spectra of the molecular species $\text{NiX}_2(\text{PMe}_3)_2(\text{P}(\text{OMe})_3)$, show two equivalent

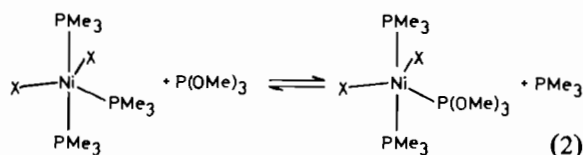

phosphines coupled to one phosphite (Table II). The chemical shift of the phosphines indicates that they are in axial positions and we thus propose a TBP geometry for these complexes, with two axial PMe_3 , one equatorial $\text{P}(\text{OMe})_3$ and two equatorial halides. The spectra of the cationic species show two equiv-

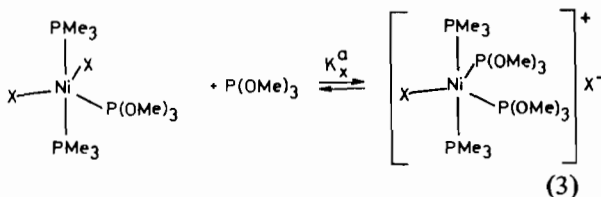

alent phosphines coupled to two equivalent phosphites. From the chemical shifts (Table II) a trigonal bipyramidal geometry with two axial PMe_3 ,

TABLE IV. Products of the Substitution Reaction of NiX_2L_3 , or Equimolar Mixtures of NiX_2L_3 and NiY_2L_3 with a Tenfold Excess of L' in CH_2Cl_2 ($\text{X}, \text{Y} = \text{Cl}, \text{Br}, \text{I}; \text{L} = \text{PMe}_3, \text{L}' = \text{P}(\text{OMe})_3$), at 173 K.

Reactants		Products				
NiX_2L_3 + excess L'	NiY_2L_3	$\text{NiX}_2\text{L}_2\text{L}'$	$\text{NiY}_2\text{L}_2\text{L}'$	$\text{NiXYL}_2\text{L}'$	$\text{NiXL}_2\text{L}'_2$	$\text{NiYL}_2\text{L}'_2$
NiCl_2L_3	—	0%	—	—	100%	—
NiBr_2L_3	—	35%	—	—	65%	—
NiI_2L_3	—	65%	—	—	35%	—
NiCl_2L_3	NiBr_2L_3	0%	0%	0%	80%	20%
NiCl_2L_3	NiI_2L_3	0%	5%	0%	90%	5%
NiBr_2L_3	NiI_2L_3	4%	12%	12%	60%	11%

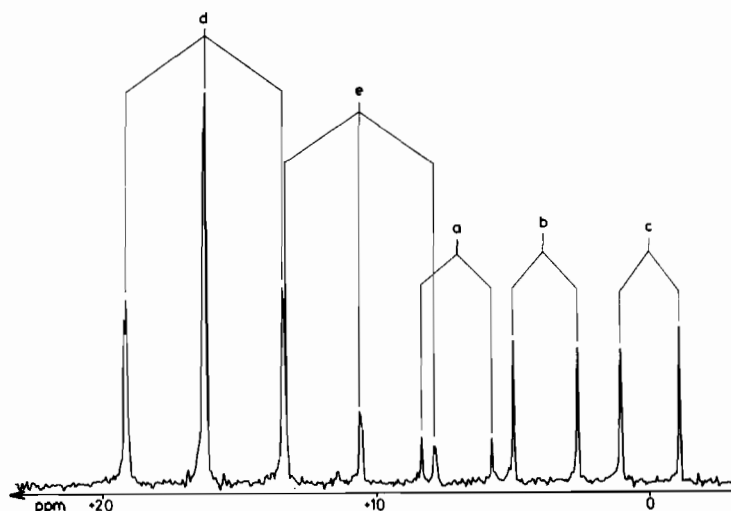
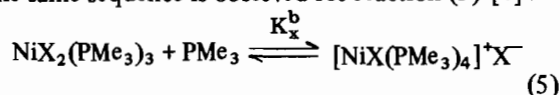

Fig. 2. $^{31}\text{P}\{^1\text{H}\}$ FT NMR spectra at 36.43 MHz of an equimolar mixture of $\text{NiBr}_2(\text{PMe}_3)_3$ and $\text{NiI}_2(\text{PMe}_3)_3$ with $\text{P}(\text{OMe})_3$ in excess ($\text{P}(\text{OMe})_3/\text{Ni} = 5$) in CH_2Cl_2 at 178 K. Showing the $\text{NiBr}_2(\text{PMe}_3)_2(\text{P}(\text{OMe})_3)$ (a), $\text{NiBr}(\text{PMe}_3)_2(\text{P}(\text{OMe})_3)$ (b), $\text{NiI}_2(\text{PMe}_3)_2(\text{P}(\text{OMe})_3)$ (c), $[\text{NiBr}(\text{PMe}_3)_2(\text{P}(\text{OMe})_3)_2]^+\text{X}^-$ (d) and $[\text{NiI}(\text{PMe}_3)_2(\text{P}(\text{OMe})_3)_2]^+\text{X}^-$ (e) species. Only the ^{31}P resonances associated to the PMe_3 ligands are shown for clarity. Numerical values in Table II.

two equatorial $\text{P}(\text{OMe})_3$ and one equatorial halide is the most probable structure. The replacement of one equatorial halide (Reaction 3) by a second phosphite is not quantitative (Table IV). The formation of the cationic species is favoured in the case of the chloro-complex and the molecular species is stabilized in the case of the iodo-complex. The sequence of the equilibrium constants for reaction (3) is:

$$K_{\text{Cl}}^a \gg K_{\text{Br}}^a > K_{\text{I}}^a \quad (4)$$

The same sequence is observed for reaction (5) [4]:



but one may note that $K_x^a < K_x^b$, i.e. halide is more easily displaced by PMe_3 .

(6)
The stereochemistries of the molecular $\text{NiX}_2(\text{PMe}_3)_2(\text{P}(\text{OMe})_3)$ and the cationic $[\text{NiX}(\text{PMe}_3)_2(\text{P}(\text{OMe})_3)_2]^+\text{X}^-$ species have been confirmed by looking at the products of the reaction of $\text{NiX}_2(\text{PMe}_3)_3$ and $\text{NiY}_2(\text{PMe}_3)_3$ (in the molar ratio 1:1) with an excess of $\text{P}(\text{OMe})_3$ ($\text{X}, \text{Y} = \text{Cl}, \text{Br}, \text{I}$). Taking the bromine-iodine system as an example (Table IV, Fig. 2), we observe the formation of the already known species: $\text{NiBr}_2(\text{PMe}_3)_2(\text{P}(\text{OMe})_3)$, $\text{NiI}_2(\text{PMe}_3)_2(\text{P}(\text{OMe})_3)$, $[\text{NiBr}(\text{PMe}_3)_2(\text{P}(\text{OMe})_3)_2]^+$ and $[\text{NiI}(\text{PMe}_3)_2(\text{P}(\text{OMe})_3)_2]^+$ plus the new species $\text{NiBrI}(\text{PMe}_3)_2(\text{P}(\text{OMe})_3)$ which is the only new one expected on the basis of the previously proposed structures.

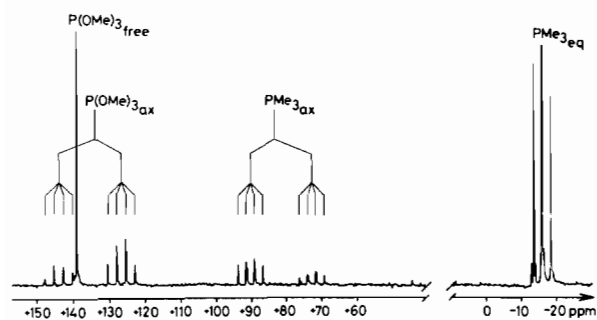

Fig. 3. $^{31}\text{P}\{^1\text{H}\}$ FT-NMR spectra at 36.43 MHz of $[\text{Ni}(\text{P}(\text{OEt})_3)(\text{PMe}_3)_4](\text{BF}_4)_2$ in CH_2Cl_2 at 180 K. One sees the low field strongly coupled AB system ($\text{PMe}_{3\text{ax}}-\text{P}(\text{OEt})_{3\text{ax}}$) coupled itself to the three equatorial phosphines at high field ($\text{PMe}_{3\text{eq}}$). Numerical values in Table II.

$[\text{NiX}(\text{PMe}_3)_4]\text{BF}_4$

Addition of $\text{P}(\text{OEt})_3$ to a solution of $[\text{NiBr}(\text{PMe}_3)_4]\text{BF}_4$ readily gives the complex $[\text{NiBr}(\text{PMe}_3)_3(\text{P}(\text{OEt})_3)]^+$ (VI) which by addition of more $\text{P}(\text{OEt})_3$ gives the complex $[\text{NiBr}(\text{PMe}_3)_2(\text{P}(\text{OEt})_3)_2]^+$ (VII). From the ^{31}P NMR spectra (Table II), the following stereochemistries are proposed:

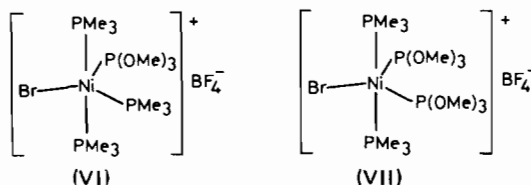
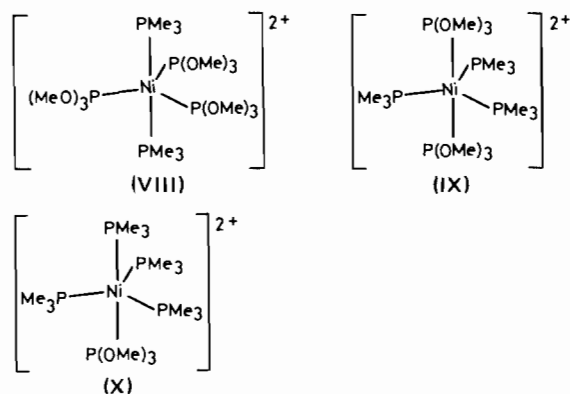

Table II shows that the NMR parameters for the cation $[\text{NiBr}(\text{PMe}_3)_2(\text{P}(\text{OEt})_3)_2]^+$ do not depend on the counterion. Further addition of $\text{P}(\text{OEt})_3$ does not lead to the displacement of the halide. Addition of $\text{P}(\text{OEt})_3$ to $[\text{NiCl}(\text{PMe}_3)_4]\text{BF}_4$ and $[\text{NiI}(\text{PMe}_3)_4](\text{BF}_4)$ was not tried. These experiments show that the replacement of the equatorial trimethylphosphine by trimethylphosphite is readily achieved in Ni(II) complexes containing halides but that the replacement of the axial phosphine does not occur. Replacement of the first halide in dihalogenocomplexes is easy but displacement of the second one with formation of dicationic pentacoordinate complexes is not possible with PMe_3 or $\text{P}(\text{OEt})_3$.

$[\text{Ni}(\text{P}(\text{OEt})_3)_5](\text{BF}_4)_2 + \text{PMe}_3$

After having investigated the ligand substitution in $\text{NiX}_2(\text{PMe}_3)_3$ and $[\text{NiX}(\text{PMe}_3)_4]\text{BF}_4$, it would be interesting to do the same experiment with $[\text{Ni}(\text{PMe}_3)_5](\text{BF}_4)_2$. However, due to the instability of $[\text{Ni}(\text{PMe}_3)_5](\text{BF}_4)_2$, which has been characterized only at low temperature (114 K) in solution [4], we started investigating the $\text{P}(\text{OEt})_3-\text{PMe}_3$ substitution with the stable $[\text{Ni}(\text{P}(\text{OEt})_3)_5](\text{BF}_4)_2$ as starting material.

Various amounts of PMe_3 were added to dichloromethane solutions of $[\text{Ni}(\text{P}(\text{OEt})_3)_5](\text{BF}_4)_2$ ($\text{PMe}_3/[\text{Ni}(\text{P}(\text{OEt})_3)_5]^{++} = 1$ to 50 molar ratio). Three mixed ligand pentacoordinate complexes were identified by ^{31}P NMR at 173 K: $[\text{Ni}(\text{PMe}_3)_2(\text{P}(\text{OEt})_3)_3]^{++}$ (VIII) is characterized by a low field triplet ($\delta = +108.9$ ppm; $J_{\text{PaPe}}' = 91$ Hz) assigned to the three equatorial phosphites and by a high field quartet ($\delta = +22.8$ ppm) attributed to the two axial phosphines. $[\text{Ni}(\text{PMe}_3)_3(\text{P}(\text{OEt})_3)_2]^{++}$ (IX) has a low field quartet ($\delta = +120$ ppm; $J_{\text{PePa}} = 97.7$ Hz) representative of the axial phosphites and a high field triplet ($\delta = -15.6$ ppm) characteristic of equatorial phosphines. The spectrum of the third species $[\text{Ni}(\text{PMe}_3)_4(\text{P}(\text{OEt})_3)]^{++}$ (X) is shown in Fig. 3. The NMR data are in Table II. A strong coupling (636 Hz) is observed between the axial phosphine and the axial phosphite ligands, along with a strong downfield shift of the axial phosphine resonance ($\delta = +83.6$ ppm). The following stereochemistries are proposed for these three species:



The complex $[\text{Ni}(\text{PMe}_3)(\text{P}(\text{OEt})_3)_4]^{++}$ has not been detected in solution. Thus, in the $[\text{Ni}(\text{P}(\text{OEt})_3)_5]^{++}-\text{PMe}_3$ system, $\text{P}(\text{OEt})_3$ is observed in the axial as well as in the equatorial position of the TBP. Therefore, it is not possible to conclude on the relative preferences of the PMe_3 or $\text{P}(\text{OEt})_3$ ligands for the equatorial or axial sites of the trigonal bipyramid.

^{31}P NMR Parameters

In contrast to the situation observed with square planar and octahedral complexes [14, 15] data on the chemical shifts and coupling constants ($^2J_{\text{PP}}$) in stereononrigid pentacoordinate d^8 nickel(II) complexes are scarce. In Fig. 3 are shown the chemical shifts of the isostructural $\text{NiX}_2(\text{PMe}_3)_3$ and $[\text{NiX}(\text{PMe}_3)_4]^+$ complexes as a function of the sum of the electronegativities of the donor atoms [16]. Two well separated chemical shift ranges are observed, the axial phosphines lying at lower field than the equatorial ones, showing that the chemical shifts are directly related to the position of the phosphines in the trigonal bipyramid (axial or equatorial). Such a result is interesting since few relations between

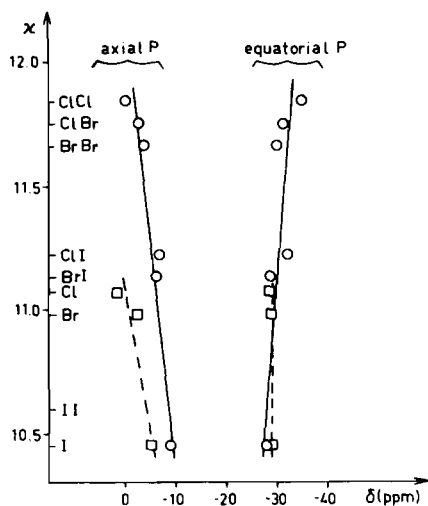

Fig. 4. ^{31}P -NMR chemical shifts of the axial and equatorial phosphines in the TBP $\text{NiXY}(\text{PMe}_3)_3$ (\circ , full line) and $[\text{NiX}(\text{PMe}_3)_4]^+$ (\square , dotted line) complexes as a function of the sum of the electronegativities of the donor atoms of the ligands, χ , in $\text{CH}_2\text{Cl}_2/\text{CD}_2\text{Cl}_2$ 1:1.

stereochemistries and chemical shifts have been reported. However, it is known that phosphorus-phosphorus coupling constants are better related to the stereochemistry of the complexes [14, 17]. In Fig. 5, the axial-equatorial coupling constants $^2J_{\text{PP}}$, of some Ni(II) complexes, are reported as a function of the sum of the electronegativities of the donor atoms. We see that in $\text{NiX}_2(\text{PMe}_3)_3$ and $[\text{NiX}(\text{PMe}_3)_4]^+$ the coupling constants lie in a narrow range (60–85 Hz) and these values may be related to χ . Similar relations have been observed in Pt(II) and Rh(I) phosphine complexes [14]. The J_{PaPe} coupling constant of 51 Hz reported by Klein *et al.* [18] in $[\text{Ni}(\text{CH}_3)(\text{PMe}_3)_4]^+$ lies in the same range.

A higher J_{PaPe} value (71.6 Hz in $\text{NiBr}_2(\text{PMe}_3)_3$ compared to 79.6 Hz for $[\text{NiBr}(\text{PMe}_3)_4]\text{BF}_4$ is observed when the number of PMe_3 ligands in the complex increases. Analogous trends are observed in the axial phosphine-equatorial phosphite coupling constants, $J_{\text{PaP'e}}$, the values of these constants lying in the range (67–100 Hz). Emphasis can be put on the $^2J_{\text{PeP'e}}$ value for 361 Hz observed for the coupling between equatorial phosphine and equatorial phosphite in $[\text{NiBr}(\text{PMe}_3)_3(\text{P}(\text{OMe})_3)]^+$ that is when the $\text{PMe}_3\text{-Ni-P}(\text{OMe})_3$ angle is about 120° and on the $J_{\text{PaP'a}}$ value of 636 Hz observed for the coupling between the axial phosphine and the axial phosphite in $[\text{Ni}(\text{PMe}_3)_4(\text{P}(\text{OMe})_3)]^{++}$ that is when the $\text{PMe}_3\text{-Ni-P}(\text{OMe})_3$ angle is about 180° . These results show an angular dependence of $^2J_{\text{PP}}$. Thus it seems possible to establish empirical relations between the complex stereochemistry and the $^2J_{\text{PP}}$ values. However, more data ($^2J_{\text{PP}}$ and δ) are needed,

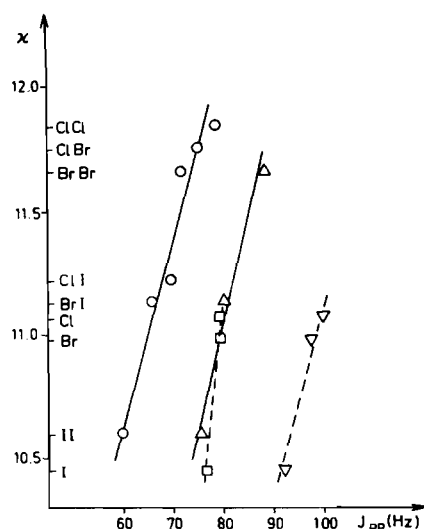

Fig. 5. Coupling constants, $^2J_{\text{PP}}$, as a function of χ in $\text{CH}_2\text{-Cl}_2/\text{CD}_2\text{Cl}_2$ 1:1: \circ $^2J_{\text{PaPe}}$ in TBP $\text{NiXY}(\text{PMe}_3)_3$; \square $^2J_{\text{PaPe}}$ in TBP $[\text{NiX}(\text{PMe}_3)_4]^+$; \triangle $^2J_{\text{PaPe}'}$ in TBP $\text{NiXY}(\text{PMe}_3)_2\text{-P}'(\text{OMe})_3$; \triangle $^2J_{\text{PaPe}'}$ in TBP $[\text{NiX}(\text{PMe}_3)_2\text{P}'(\text{OMe})_2]^+$.

especially in the case of square pyramidal complexes, before one may be able to safely relate the NMR parameters to the structure and stereochemistry of pentacoordinate d^8 nickel(II) complexes.

Conclusion

This study has shown that the Ni(II) pentacoordinate $\text{NiXY}(\text{PMe}_3)_3$ ($X, Y = \text{Cl}, \text{Br}, \text{I}$) are TBP complexes with the halide in equatorial positions. Reaction of $\text{P}(\text{OMe})_3$ with $\text{NiX}_2(\text{PMe}_3)_3$ ($X = \text{CN}, \text{Cl}, \text{Br}, \text{I}$) or $[\text{NiX}(\text{PMe}_3)_4]^+$ leads to the displacement of one or two of the equatorial ligands by the phosphite, one halide always remaining in an equatorial site. Reaction of PMe_3 with $[\text{Ni}(\text{P}(\text{OMe})_3)_5]^{++}$ leads to pentacoordinate TBP complexes having either the phosphine or the phosphite ligands in an axial position, thus showing that no conclusion can be drawn on the preferred stereospecificity of these two ligands.

Acknowledgments

We thank the Swiss National Science Foundation for financial support under grant number 2.189-0.78.

References

- 1 Based, in part, on the *Ph.D. Thesis* of P.F.M., *Université de Lausanne* (1979).

- 2 C H Langford and H B Gray, 'Ligand Substitution Processes', W. A. Benjamin, New York (1966) and F Basolo and R Pearson, 'Mechanisms of Inorganic Reactions', Wiley, New York (1967)
- 3 J S Miller and K G Caulton, *Inorg Chem*, **14**, 2296 (1975)
- 4 P F Meier, A E Merbach, M Dartiguenave and Y Dartiguenave, *J Am Chem Soc*, **98**, 6402 (1976), *Chem Commun*, **49**, (1979), *Inorg Chem*, **18**, 610 (1979)
- 5 M Dartiguenave, Y Dartiguenave, A Gleizes, C Saint-Joly, J Galy, P F Meier and A E Merbach, *Inorg Chem*, **17**, 3503 (1978)
- 6 C Saint-Joly, M Dartiguenave and Y Dartiguenave, 'Inorganic Compounds with Unusual Properties II', *Advances in Chemistry Series*, **173** (1978)
- 7 W Wolfsberger and H Schmidbauer, *Syn Inorg Metal-Org Chem*, **4**, 149 (1974)
- 8 A Merle, M Dartiguenave, Y Dartiguenave, J W Dawson and H B Gray, *J Coord Chem*, **3**, 199 (1974)
- 9 J W Dawson, T J McLennan, W Robinson, A Merle, M Dartiguenave, Y Dartiguenave and H B Gray, *J Am Chem Soc*, **96**, 4428 (1974)
- 10 K J Coskran, T J Huttermann and J G Verkade, *Advan Chem Ser*, **62**, 590 (1966)
- 11 C Ammann, P F Meier, and A E Merbach, to be published
- 12 P Meakin and J P Jesson, *J Am Chem Soc*, **96**, 5751 (1974)
- 13 J K Stalck and J A Ibers, *Inorg Chem*, **8**, 1083 and 1090 (1969)
- 14 J F Nixon and A Pidcock, *Annu Rev NMR Spectroscopy*, **2**, 345 (1969)
- 15 C A Tolman, *Chem Reviews*, **77** (1977)
- 16 A L Allred and E G Rochow, *J Inorg Nucl Chem*, **5**, 264 (1958)
- 17 D L Dubois and D W Meek, *Inorg Chem*, **15**, 3076 (1976)
- 18 H F Klein, H H Karsch and W Buchner, *Chem Ber*, **107**, 537 (1974)